

PLAN

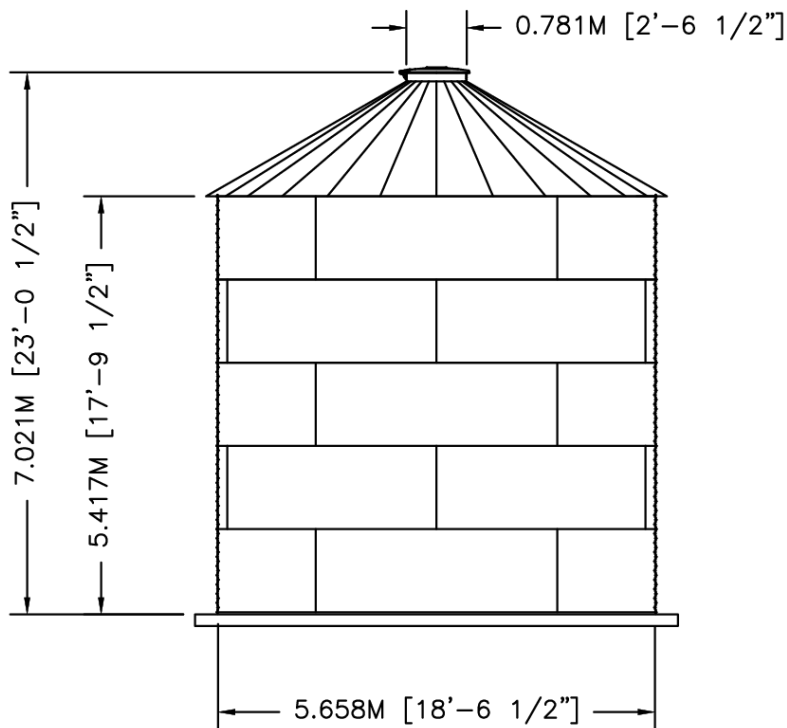

ELEVATION

	BY	DATE	TITLE	
DWN	XXX	XX/XX/XX	WTU06-05 30"PR 30DEG V-RIB	
CKD			NOMINAL CAPACITY - 133.133 M3 [35,170 GAL]	
ENG			DWG. NO. SCT1805-VR WTU06-05	REV. NO.
SIZE: A		SCALE: 1/8"=1'-0"		SHEET 1 OF 1

